

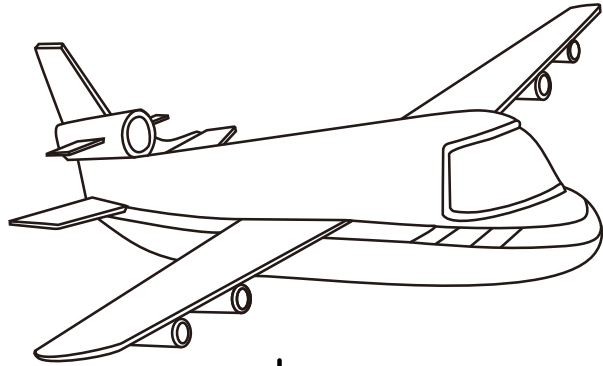

Activity 1

Color the pictures. Say the name of each picture.



plane



helicopter

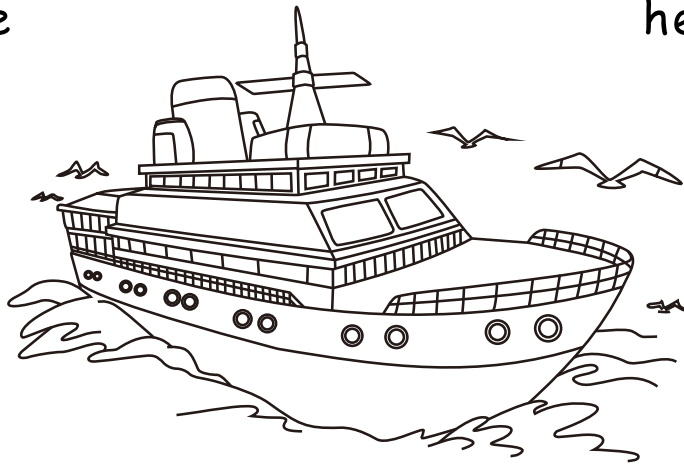

ship

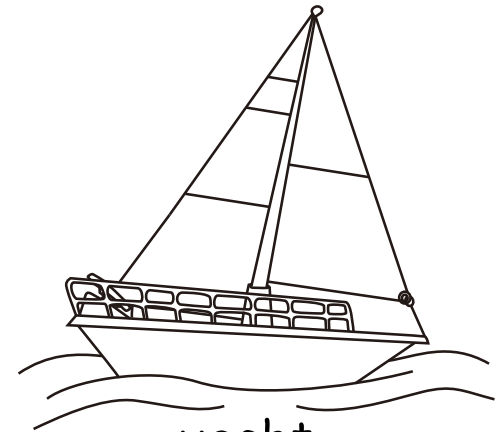

yacht

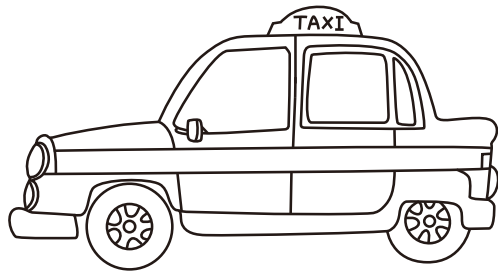

taxi

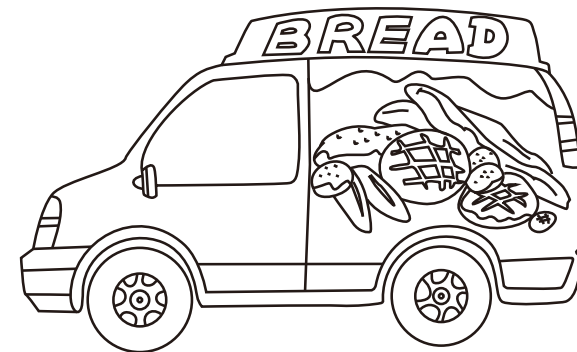

van

(Visit www.alyssaliang.com for more free learning material.)



Activity 2 Match the people to their type of transport. What do they do?



driver



driver



sailor



sailor



pilot



pilot



(Visit www.alyssaliang.com for more free learning material.)



Activity 3

Say the sound of each letter. Color the picture that begins with the same sound.

p

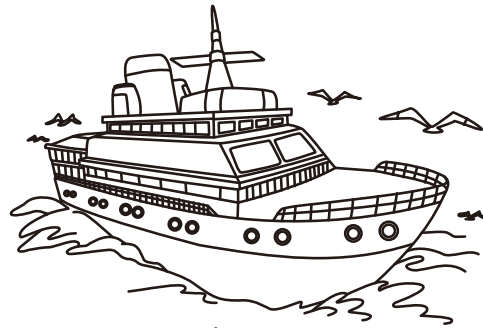

ship

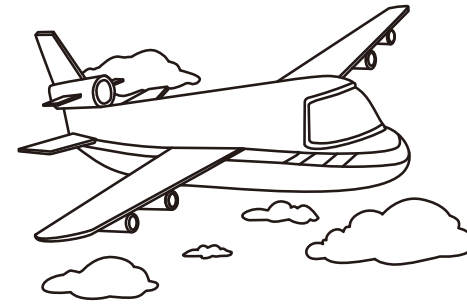

plane

t

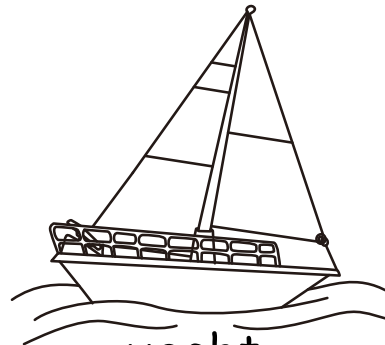

yacht



taxi

v

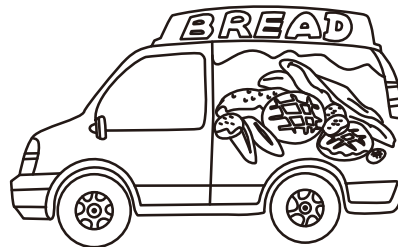

van



helicopter



Activity 4

Review sounds. Say the sound of each letter. Color the picture that begins with the same sound.

b

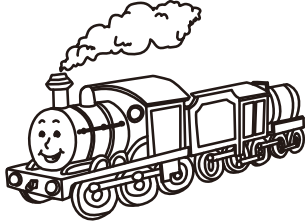

train



bus

m



motorbike

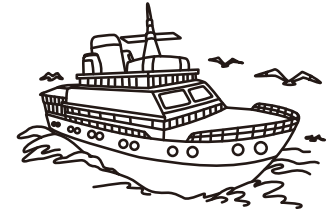

ship

c



car



boat

t



taxi

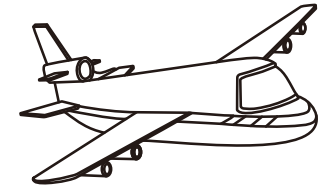

plane

h



helicopter

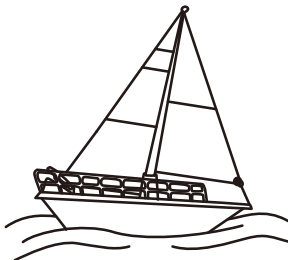

yacht

v

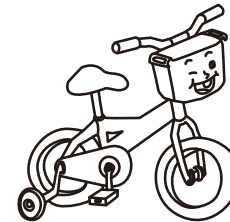

bike



van

(Visit www.alyssaliang.com for more free learning material.)



Activity 5

Test your understanding of the story. Who are these people? What do they do?

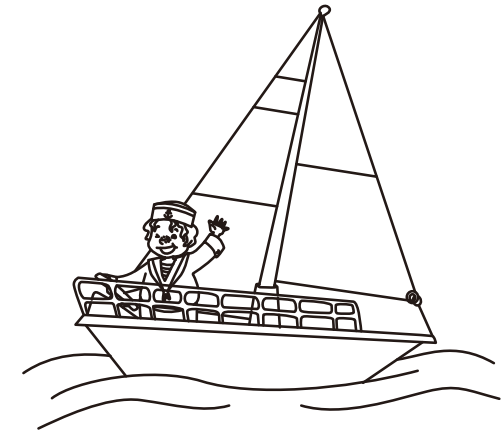
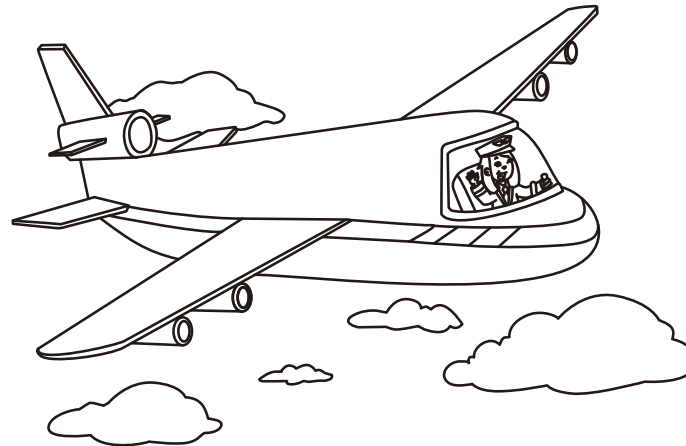
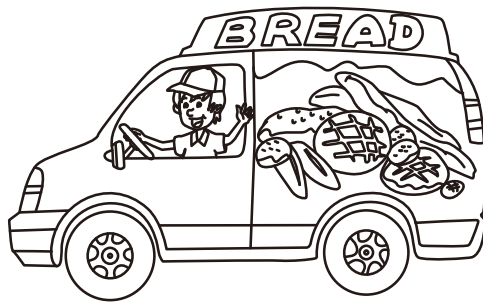
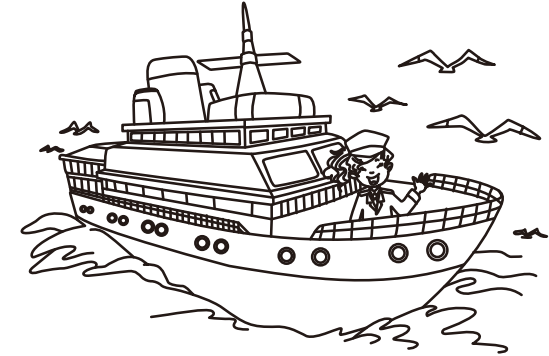

Teacher's comments: _____

(Visit www.alyssaliang.com for more free learning material.)